



# ecocirc<sup>®</sup> e<sup>3</sup> Series

WHOLE HOUSE POTABLE WATER CIRCULATORS

A-133C

 **Bell & Gossett**  
a xylem brand

# ecocirc e<sup>3</sup> series

Whole house potable water circulators

The first pump to run off  
of 10 watts - about the same  
as a night light!

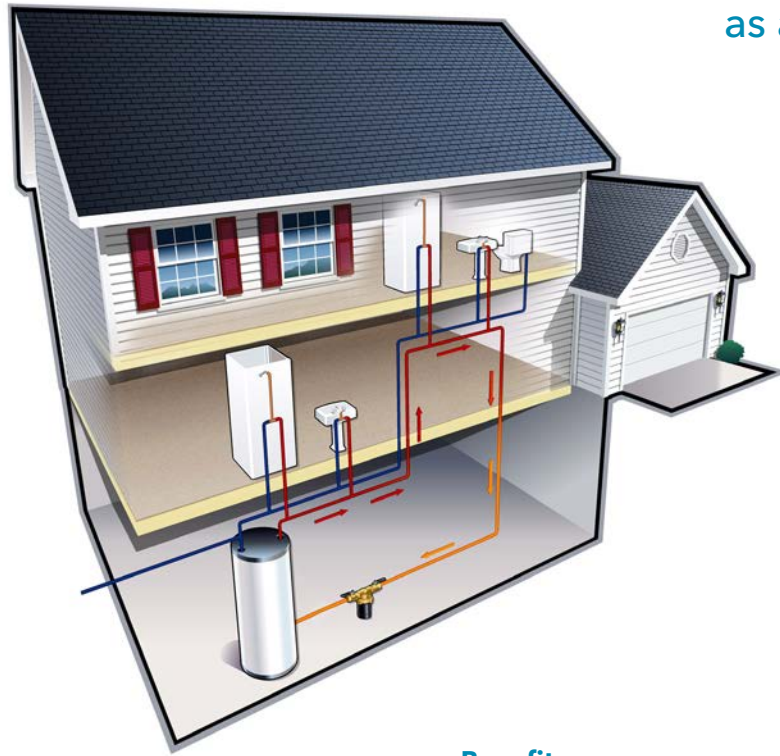

## Features

- Easy installation
- Programmable timer and built-in thermostat available to further reduce energy consumption.
- Available with integrated check and ball valves for quick isolation during service.

## Benefits

- Instant availability of hot water, even at the tap farthest from the hot water heater.
- Conserves natural resources - reduced power consumption, CO<sub>2</sub> emissions and wasted water.

## Energy Efficient Due to ECM Technology

The ecocirc pumps' highly efficient ECM (Electronically Commutated Motor) design results in significant energy savings with improved performance: Through microprocessor technology the motor is provided the precise frequency and voltage for optimum performance. A permanent magnet motor eliminates the requirement for input power to magnetize the rotor, thus maximizing efficiency. This unique design offers superior starting torque when compared with standard induction motor type pumps.

### The spherical motor design:

The only moving part of this pump type is a spherical rotor/impeller unit which is suspended on an extremely wear resistant ceramic ball. Shaft seals or conventional bearing bushings with a shaft have been eliminated. The only self realigning bearing in the small pump market has many advantages:

- The suspension on a ball eliminates any bearing play, even after years of use.

- The bearing is self-realigning. It is automatically lubricated and cooled by the system fluid.
- The rotor is magnetically centered on the bearing and therefore can tilt to avoid blockage by small dirt particles. Even after a long time of shut-off, a safe start-up is virtually guaranteed.
- The pump can be cleaned easily with typical household cleaners in the unlikely case of scale deposits. Integrated step-less scale protection thermostats are optional.

### Adjustable Thermostat Option

For models with the adjustable thermostat, there is an adjustable Set Point range from 68°F to 158°F (20°C to 70°C). This built-in temperature sensor will turn the circulator off when it reaches the Set Point and turn the circulator on when the temperature is more than 10°F (6°C) below the Set Point. The adjustable thermostat is only available on fixed-speed motors.

# ecocirc e<sup>3</sup> pump curves

e<sup>3</sup> - 4 Pump Curves

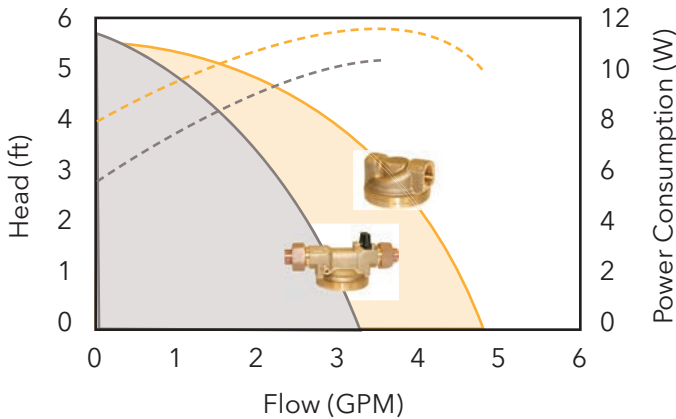

e<sup>3</sup> - 6 Pump Curves

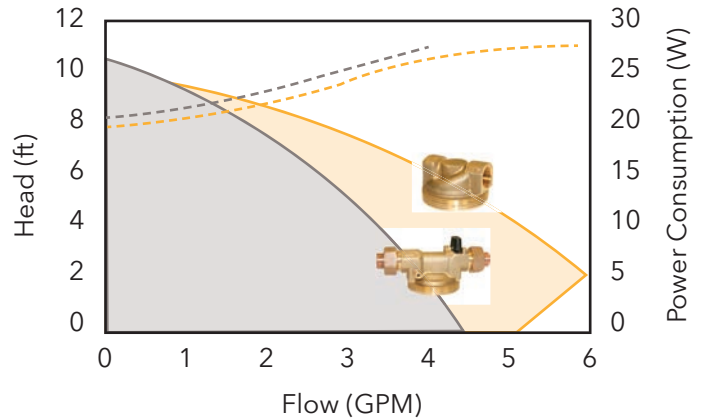

— UltraCirc Housing Flow      - - - UltraCirc Housing Energy Consumption  
 — NPT/Sweat Housing Flow      - - - NPT/Sweat Housing Energy Consumption

- Saves 68% electricity compared to a standard circulating pump
- Long lasting, silent operation
- Maintenance free without blockage
- Highly efficient ECM technology
- Resistant to scale build up
- Single bearing design
- No shaft, no seal

## Vario

A standard feature that allows for stepless speed control to enable you to set the pump performance to individual system requirements.

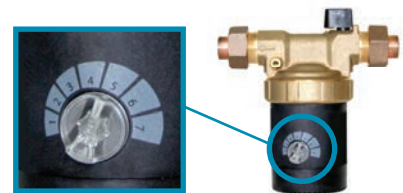

## e<sup>3</sup>-Timer

### Description

To increase the overall efficiency of a domestic hot water recirculating system and to reduce water wasted while waiting for hot water, the e<sup>3</sup> Timer can be installed on all e<sup>3</sup> pumps. The timer is easily installed by removing the motor end cap, plugging in the timer and setting the timer schedule without any wiring. The timer can be used in 3-different selections: ON, OFF and TIMER. The ON selection operates the pump continuously, the OFF selection turns the pump OFF and the TIMER selection (depicted by a clock on the timer) turns the pump on when programmed.

### Operational Limits

Power Supply: Internally powered by the e<sup>3</sup> circulating pump.

Minimum Switch Interval: 30 minutes.

Run Modes: ON (Continuous), OFF (Off at all times) and TIMER (run at programmed intervals)

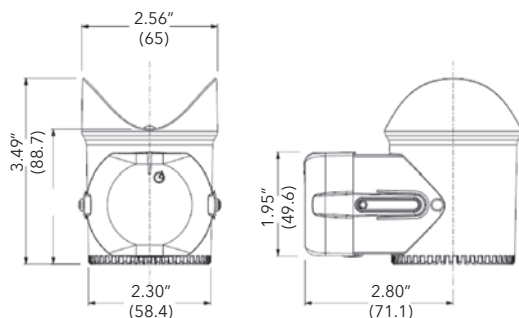

## Available Models

Model Number	Part Number	Materials	Connection		Adjustable Speed	Adjustable Thermostat	Plug
			Size	Type			
e <sup>3</sup> -4V/BSPYZ	LHB08100101	Lead-Free Brass*	1/2"	Sweat	•		•
e <sup>3</sup> -4_/BSXRZ	LHB08100102	Lead-Free Brass*	1/2"	Sweat		•	
e <sup>3</sup> -4V/BTXYZ	LHB08100104	Lead-Free Brass*	1/2"	FNPT	•		
e <sup>3</sup> -4_/BTPRZ	LHB08100106	Lead-Free Brass*	1/2"	FNPT		•	•
e <sup>3</sup> -4V/BUPYZ	6050B5002	Lead-Free Brass*	1/2"	Union	•		•
e <sup>3</sup> -4_/BUPRZ	6050B5003	Lead-Free Brass*	1/2"	Union		•	•
e <sup>3</sup> -6V/BSPYZ	LHB08100109	Lead-Free Brass*	1/2"	Sweat	•		•
e <sup>3</sup> -6V/BTXYZ	LHB08100112	Lead-Free Brass*	1/2"	FNPT	•		
e <sup>3</sup> -6V/BTPYZ	LHB08100110	Lead-Free Brass*	1/2"	FNPT	•		•
e <sup>3</sup> -6_/BUPYZ	6050B5004	Lead-Free Brass*	1/2"	Union	•		•
e <sup>3</sup> -6_/BSPRZ	6050B5006	Lead-Free Brass*	1/2"	Sweat		•	•
e <sup>3</sup> -Timer	LHB08260002						

\*Lead-Free Brass certify to NSF 372.

## Available Bronze Housing

UCT with Ball & Check Valve



1/2" Threaded/Sweat



UltraCirc Pump Housing  
(Union with Ball & Check Valve)

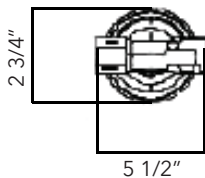
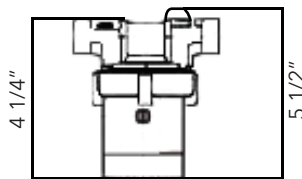

Standard Pump Housing  
(Sweat & Threaded)

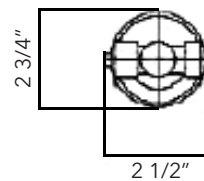
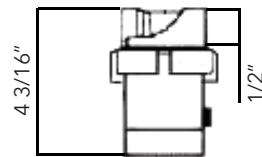

Xylem Inc.  
8200 N. Austin Avenue  
Morton Grove, Illinois 60053  
Phone: (847) 966-3700  
Fax: (847) 965-8379  
[www.bellgossett.com](http://www.bellgossett.com)

Bell & Gossett is a trademark of Xylem Inc. or one of its subsidiaries.  
© 2015 Xylem Inc. A-133C July 2015